



FIRE Retardants Inc.™

The Decision You Make May Save A Life!

123 Columbia Court North • Suite 201 • Chaska, MN 55318

952-448-7377 • FAX: 952-448-2613

Fire Retardant "HOT LINE" 1-800-913-9385

e-mail: info@fireretardantsinc.com

Visit Our Web Site at www.fireretardantsinc.com

3M

Fire Barrier Ultra PPD Plastic Pipe Device 1, 2 and 3 Hour



Through-Penetration
Firestop Device (XHJI)
Classified by
Underwriters
Laboratory, Inc. See UL
Fire Resistance
Directory R9269 90G8

Product Data

1. Product Description

The 3M Plastic Pipe Device is a one piece metal collar assembly encasing 3M's heat expanding 3M™ Interam™ Ultra GS (intumescent) material. Manufactured with 3M's firestop technology, it has been contract or designed and UL Classified.

The 3M Plastic Pipe Device is used for new and retrofit installations and will accommodate 12 inch (38 mm) 2 inch (5 cm), 3 inch (7 cm) and 4 inch (10 cm) schedule 40 drain, waste and vent pipe systems. The 3M Plastic Pipe Device achieved up to 3 hour fire ratings when tested by Underwriters Laboratories, Inc. in accordance with ASTM E 814 (UL1479)

Product Features

- Ultra fast anchoring system
- One piece - makes installation easier and quicker
- Factory made - assures consistent quality
- Proven technology — Intumescent action quickly seals off plastic pipe in a fire
- UL Classified-meets code requirements - universally recognized
- Red color—easily identified as a fire rated device during inspections
- Embossed 3M and UL logos

2. Applications

The 3M Ultra PPD is used to seal ccPVC, PVC, CPVC, FRPP, PVDF, ccABS and ABS pipes penetrating 1 and 2 hour floor/ceiling assemblies and 1, 2 and 3 hour fire rated gypsum wall-board assemblies and up to 3 hour fire rated concrete wall, floor or hollow core assemblies.

It may be applied to drain, waste and vent or closed pipe systems. See manufacturer's instruction sheet supplied with each device for exact types of plastic pipe covered and hourly ratings.

3. Physical Properties

See Table 1 below.

4. Specifications

Installations shall be in strict accordance with manufacturer's written instructions, as shown on approved shop drawings.

The device shall also be classified by Underwriter's Laboratory Inc. as a through-penetration firestop device when tested in accordance with ASTM E 814 (UL 1479) for up to 3 hour rating.

All penetrations must be firestopped with a UL Classified system or device as listed in current UL Fire Resistance Directory or have approved shop drawing prior to installation.

Suitability for the intended service application should be determined prior to installation.

Table 1 - Physical Properties

Color	Red	Red	Red	Red
Nominal Pipe Size	1 1/2" (38 mm)	2" (5 cm)	3" (7 cm)	4" (10 cm)
Units per carton	10	10	10	10

Table 2 - Sizes

Size	Part No.	Fire (F) Rating
1 1/2" (38 mm)	PPD-1.5	3 hour
2" (5 cm)	PPD-2.0	3 hour
3" (7 cm)	PPD-3.0	3 hour
4" (10 cm)	PPD-4.0	3 hour

5. Performance

- UL tests per ASTM E 814(UL 1479)
- UL classified 1, 2 and 3 hour fire (F) and temperature (T) rating. See UL Fire Resistance Directory under Through-Penetration Firestop Device (XHCR) R9269(N) 90G8.
- ULC

6. Installation

The back page shows an example of a UL classified system using the 3M Ultra PPD with Ultra Fast Anchor Straps in a 3 hour concrete floor application. See PPD installation instruction sheet for additional details.

7. Maintenance

3M Fire Barrier Plastic Pipe Devices are stable under normal storage conditions. Normal stock and stock rotation practices are recommended.

8. Availability

3M Fire Barrier Plastic Pipe Devices are available from Authorized 3M Fire Protection Products Distributors.

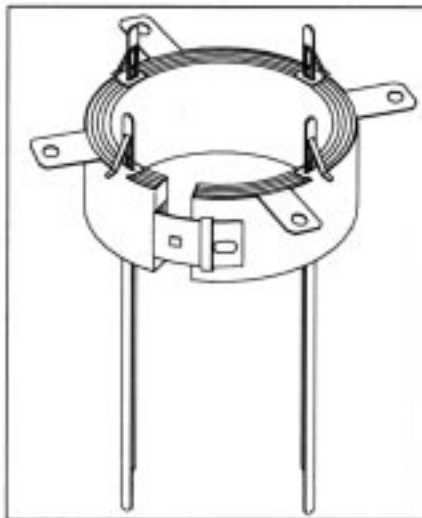

Figure 1: PPD & Ultra Fast Anchor

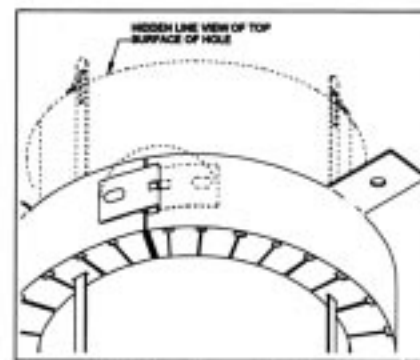

Figure 2: PPD positioned and anchor straps inserted

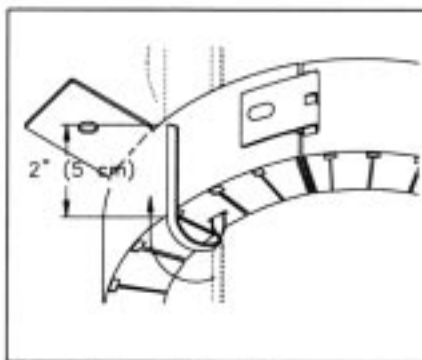

Figure 3: Ultra Fast Anchor Strap and PPD secured and locked into position.

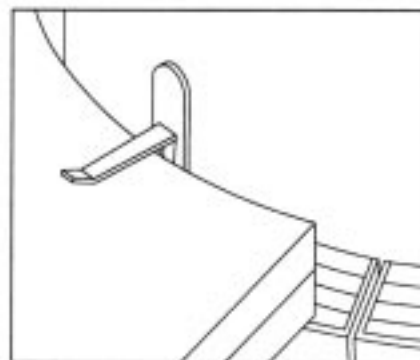

Figure 4: Top view of Ultra Fast Anchor Strap in place after installation complete.

Warranty and Limited Remedy. This product will be free from defects in material and manufacture for a period of ninety (90) days from date of purchase. **3M MAKES NO OTHER WARRANTIES INCLUDING, BUT NOT LIMITED TO, ANY IMPLIED WARRANTY OF MERCHANTABILITY OR FITNESS FOR A PARTICULAR PURPOSE.** User is responsible for determining whether the 3M product is fit for a particular purpose and suitable for user's method of application. If this 3M product is proved to be defective within the warranty period stated above, your exclusive remedy and 3M's sole obligation shall be, at 3M's option, to replace or repair the 3M product or refund the purchase price of the 3M product.Ī

Limitation of Liability Except where prohibited by law, 3M will not be liable for any loss or damages arising from the use of this 3M product, whether direct, indirect, special, incidental or consequential, regardless of the legal theory asserted, including warranty, contract, negligence or strict liability.

3M

Consumer Construction Products Department

Printed in U.S.A.

©3M 1999 98-0400-4926-8 Feb 1999

FIRE Retardants Inc.[™]
The Decision You Make May Save A Life!

123 Columbia Court North • Suite 201 • Chaska, MN 55318
952-448-7377 • FAX: 952-448-2613
Fire Retardant "HOT LINE" 1-800-913-9385